

AOSONG

Temperature and humidity module

DHT11 Product Manual

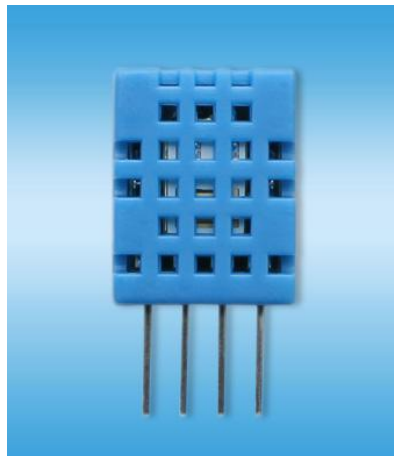

www.aosong.com

1、 Product Overview

DHT11 digital temperature and humidity sensor is a composite Sensor contains a calibrated digital signal output of the temperature and humidity. Application of a dedicated digital modules collection technology and the temperature and humidity sensing technology, to ensure that the product has high reliability and excellent long-term stability. The sensor includes a resistive sense of wet components and an NTC temperature measurement devices, and connected with a high-performance 8-bit microcontroller.

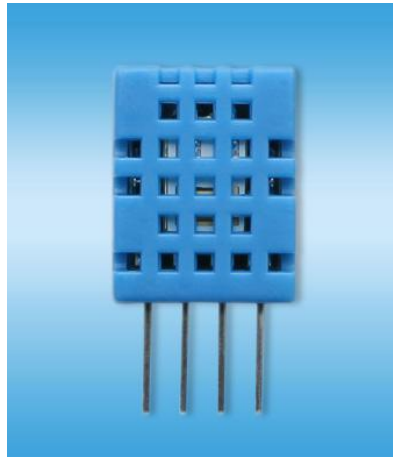

2、 Applications

HVAC, dehumidifier, testing and inspection equipment, consumer goods, automotive, automatic control, data loggers, weather stations, home appliances, humidity regulator, medical and other humidity measurement and control.

3、 Features

Low cost, long-term stability, relative humidity and temperature measurement, excellent quality, fast response, strong anti-interference ability, long distance signal transmission, digital signal output, and precise calibration.

4、 Dimensions (unit: mm)

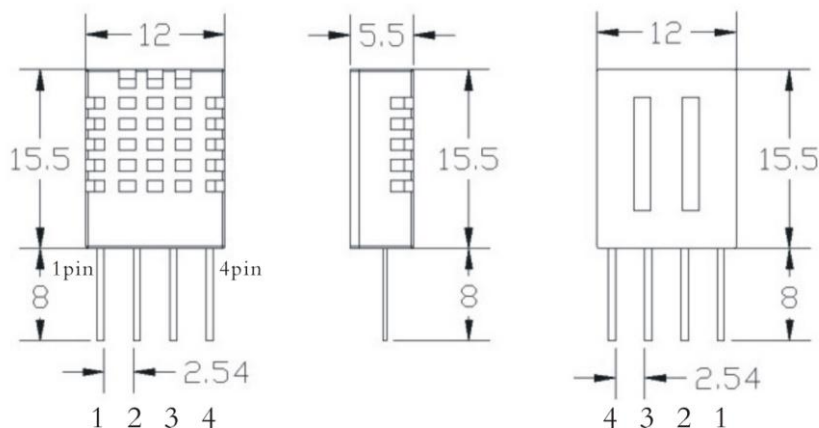

5、Product parameters

Relative humidity

Resolution: 16Bit

Repeatability: $\pm 1\%$ RH

Accuracy: At 25°C $\pm 5\%$ RH

Interchangeability: fully interchangeable

Response time: 1 / e (63%) of 25°C 6s

1m / s air 6s

Hysteresis: $< \pm 0.3\%$ RH

Long-term stability: $< \pm 0.5\%$ RH / yr in

Temperature

Resolution: 16Bit

Repeatability: $\pm 0.2^\circ\text{C}$

Range: At 25°C $\pm 2^\circ\text{C}$

Response time: 1 / e (63%) 10S

Electrical Characteristics

Power supply: DC 3.5 ~ 5.5V

Supply Current: measurement 0.3mA standby 60 μ A

Sampling period: more than 2 seconds

Pin Description

1, the VDD power supply 3.5 ~ 5.5V DC

2 DATA serial data, a single bus

3, NC, empty pin

4, GND ground, the negative power

6、Typical circuit

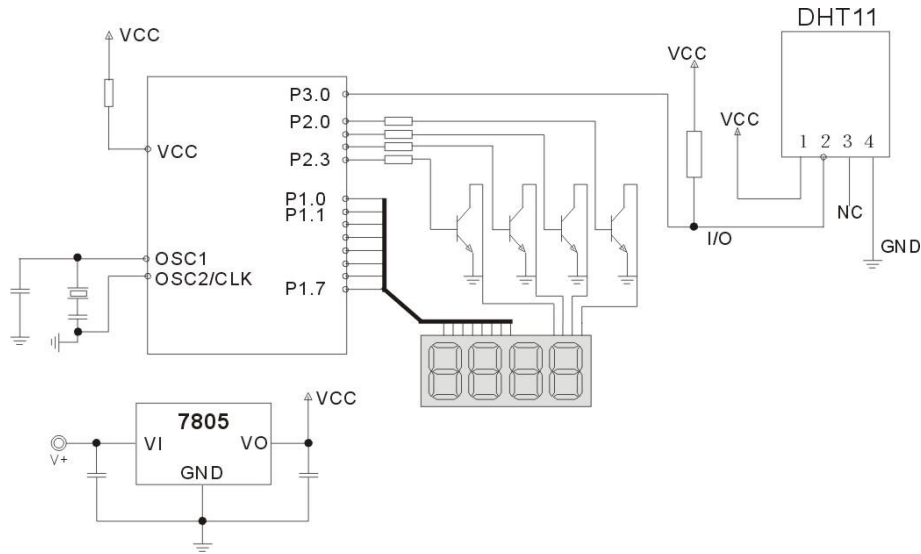

Microprocessor and DHT11 of connection typical application circuit as shown above, DATA pull the microprocessor I / O ports are connected.

1. Typical application circuit recommended in the short cable length of 20 meters on the 5.1K pull-up resistor, the resistance of greater than 20 meters under the pull-up resistor on the lower of the actual situation.
2. When using a 3.5V voltage supply cable length shall not be greater than 20cm. Otherwise, the line voltage drop will cause the sensor power supply shortage, caused by measurement error.
3. Each read out the temperature and humidity values are the results of the last measurement For real-time data, sequential read twice, but is not recommended to repeatedly read the sensors, each read sensor interval is greater than 5 seconds can be obtained accurate data.

7、Serial communication instructions (single-wire bi-directional)

©Single bus Description

DHT11 uses a simplified single-bus communication. Single bus that only one data line, the system of data exchange, control by a single bus to complete. Device (master or slave) through an open-drain or tri-state port connected to the data line to allow the device does not send data to release the bus, while other devices use the bus; single bus usually require an external one about 5.1kΩ pull-up resistor, so that when the bus is idle, its status is high. Because they are the master-slave structure, and only when the host calls the slave, the slave can answer, the host access devices must strictly follow the single-bus sequence, if the chaotic sequence, the device will not respond to the host.

©Single bus to transfer data defined

DATA For communication and synchronization between the microprocessor and DHT11, single-bus data format, a transmission of 40 data, the high first-out.

Data format:

The 8bit humidity integer data + 8bit the Humidity decimal data +8 bit temperature integer data + 8bit fractional temperature data +8 bit parity bit.

©Parity bit data definition

“8bit humidity integer data + 8bit humidity decimal data +8 bit temperature integer data + 8bit temperature fractional data” 8bit checksum is equal to the results of the last eight.

Example 1: 40 data is received:

<u>0011 0101</u>	<u>0000 0000</u>	<u>0001 1000</u>	<u>0000 0000</u>	<u>0100 1101</u>
High humidity 8	Low humidity 8	High temp. 8	Low temp. 8	Parity bit

Calculate:

0011 0101+0000 0000+0001 1000+0000 0000= 0100 1101

Received data is correct;

Humidity: 0011 0101=35H=53%RH

Temperature: 0001 1000=18H=24°C

Example 2: 40 data is received:

<u>0011 0101</u>	<u>0000 0000</u>	<u>0001 1000</u>	<u>0000 0000</u>	<u>0100 1001</u>
High humidity 8	Low humidity 8	High temp. 8	Low temp. 8	Parity bit

Calculate:

0011 0101+0000 0000+0001 1000+0000 0000 = 0100 1101

01001101 ≠ 0100 1001

The received data is not correct, give up, to re-receive data.

©Data Timing Diagram

User host (MCU) to send a signal, DHT11 converted from low-power mode to high-speed mode, until the host began to signal the end of the DHT11 send a response signal to send 40bit data, and trigger a letter collection. The signal is sent as shown.

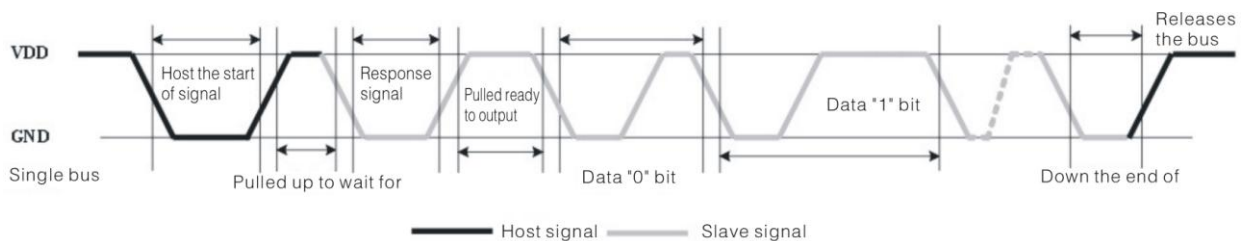

Data Timing Diagram

Note: The host reads the temperature and humidity data from DHT11 always the last measured value, such as twice the measured interval of time is very long, continuous read twice to the second value of real-time temperature and humidity values.

©Peripherals read steps

Communication between the master and slave can be done through the following steps (peripherals (such as microprocessors) read DHT11 the data of steps).

Step 1:

After power on DHT11 (DHT11 on after power to wait 1S across the unstable state during this period can not send any instruction), the test environment temperature and humidity data, and record the data, while DHT11 the DATA data lines pulled by pull-up resistor has been to maintain high; the DHT11 the DATA pin is in input state, the moment of detection of external signals.

Step 2:

Microprocessor I / O set to output at the same time output low, and low hold time can not be less than 18ms, then the microprocessor I / O is set to input state, due to the pull-up resistor, a microprocessor/ O DHT11 the dATA data lines also will be high, waiting DHT11 to answer signal, send the signal as shown:

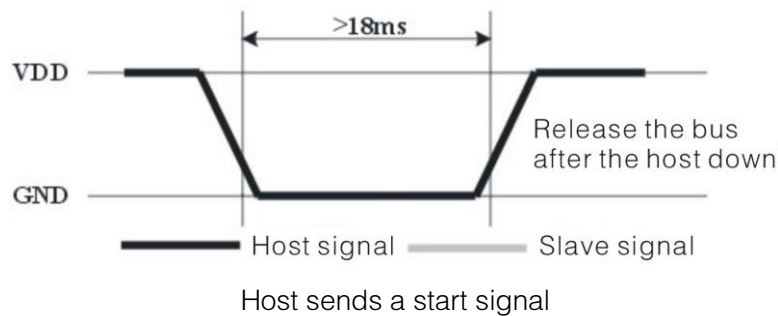

Step 3:

DATA pin is detected to an external signal of DHT11 low, waiting for external signal low end the delay DHT11 DATA pin in the output state, the output low of 80 microseconds as the response signal, followed by the output of 80 micro-seconds of high notification peripheral is ready to receive data, the microprocessor I / O at this time in the input state is detected the I / O low (DHT11 response signal), wait 80 microseconds high data receiving and sending signals as shown:

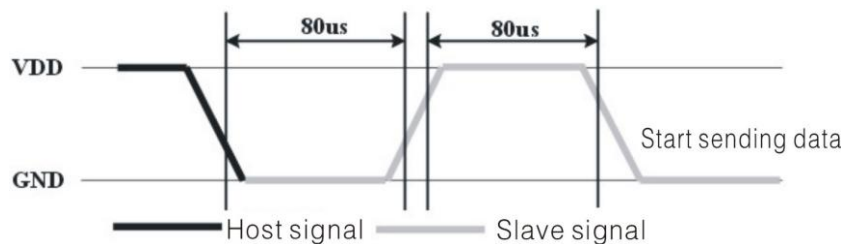

Step 4:

Output by DHT11 the DATA pin 40, the microprocessor receives 40 data bits of data "0" format: the low level of 50 microseconds and 26-28 microseconds according to the changes in the I / O levellevel, bit data "1" format: the high level of low plus, 50 microseconds to 70 microseconds. Bit data "0", "1" signal format as shown:

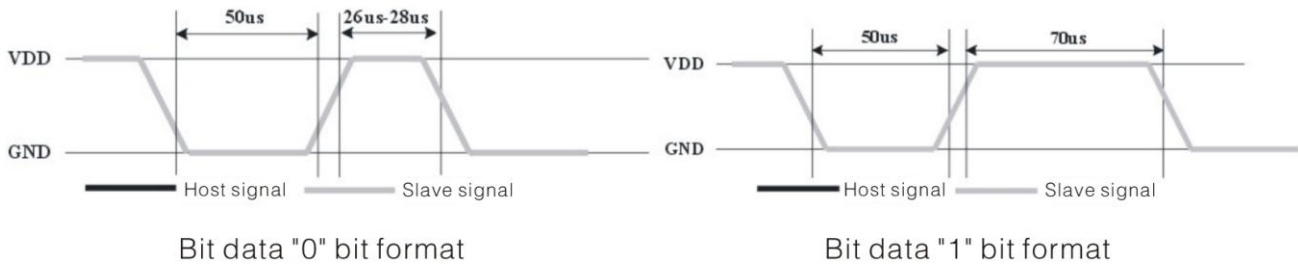

End signal:

Continue to output the low 50 microseconds after DHT11 the DATA pin output 40 data, and changed the input state, along with pull-up resistor goes high. But DHT11 internal re-test environmental temperature and humidity data, and record the data, waiting for the arrival of the external signal.

8、 Application of information

1. Work and storage conditions

Outside the sensor the proposed scope of work may lead to temporary drift of the signal up to 300%RH. Return to normal working conditions, sensor calibration status will slowly toward recovery. To speed up the recovery process may refer to "resume processing". Prolonged use of non-normal operating conditions, will accelerate the aging of the product.

Avoid placing the components on the long-term condensation and dry environment, as well as the following environment.

A, salt spray

B, acidic or oxidizing gases such as sulfur dioxide, hydrochloric acid

Recommended storage environment

Temperature: 10 ~ 40 °C Humidity: 60% RH or less

2. The impact of exposure to chemicals

The capacitive humidity sensor has a layer by chemical vapor interference, the proliferation of chemicals in the sensing layer may lead to drift and decreased sensitivity of the measured values. In a pure environment, contaminants will slowly be released. Resume processing as described below will accelerate this process. The high concentration of chemical pollution (such as ethanol) will lead to the complete damage of the sensitive layer of the sensor.

3. The temperature influence

Relative humidity of the gas to a large extent dependent on temperature. Therefore, in the measurement of humidity, should be to ensure that the work of the humidity sensor at the same temperature. With the release of heat of electronic components share a printed circuit board, the installation should be as far as possible the sensor away from the electronic components and mounted below the heat source, while maintaining good ventilation of the enclosure. To reduce the thermal conductivity sensor and printed circuit board copper plating should be the smallest possible, and leaving a gap between the two.

4. Light impact

Prolonged exposure to sunlight or strong ultraviolet radiation, and degrade performance.

5. Resume processing

Placed under extreme working conditions or chemical vapor sensor, which allows it to return to the status of calibration by the following handler. Maintain two hours in the humidity conditions of 45°C and <10% RH (dry); followed by 20–30°C and > 70% RH humidity conditions to maintain more than five hours.

6. Wiring precautions

The quality of the signal wire will affect the quality of the voltage output, it is recommended to use high quality shielded cable.

7. Welding information

Manual welding, in the maximum temperature of 300°C under the conditions of contact time shall be less than 3 seconds.

8. Product upgrades

Details, please the consultation Aosong electronics department.

9、 The license agreement

Without the prior written permission of the copyright holder, shall not in any form or by any means, electronic or mechanical (including photocopying), copy any part of this manual, nor shall its contents be communicated to a third party. The contents are subject to change without notice.

The Company and third parties have ownership of the software, the user may use only signed a contract or software license.

10、 Warnings and personal injury

This product is not applied to the safety or emergency stop devices, as well as the failure of the product may result in injury to any other application, unless a particular purpose or use authorized. Installation, handling, use or maintenance of the product refer to product data sheets and application notes. Failure to comply with this recommendation may result in death and serious personal injury. The Company will bear all damages resulting personal injury or death, and waive any claims that the resulting subsidiary company managers and employees and agents, distributors, etc. that may arise, including: a variety of costs, compensation costs, attorneys' fees, and so on.

11、 Quality Assurance

The company and its direct purchaser of the product quality guarantee period of three months (from the date of delivery). Publishes the technical specifications of the product data sheet shall prevail. Within the warranty period, the product was confirmed that the quality is really defective, the company will provide free repair or replacement. The user must satisfy the following conditions:

- ① The product is found defective within 14 days written notice to the Company;
- ② The product shall be paid by mail back to the company;
- ③ The product should be within the warranty period.

The Company is only responsible for those used in the occasion of the technical condition of the product defective product. Without any guarantee, warranty or written statement of its products used in special applications. Company for its products applied to the reliability of the product or circuit does not make any commitment.